

**2024
Summer**

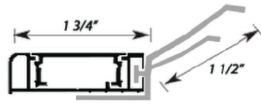
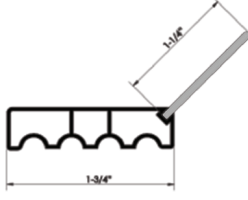
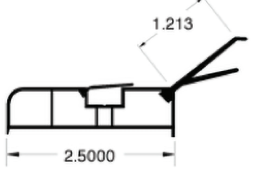

Elton
MANUFACTURING
Garage Door
Catalogue

Side and top Rigid PVC

| Model | Image | Length | Box Quantity | Material | Colours | Description |
|----------|---|---|--------------|---|--|--|
| SR-1104 |  | 7', 8', 9', 10', 12', 14', 16', 18' | 12 | Rigid PVC/ Flexible PVC | White, Black, Cream, Sandstone Desert Sandstone Brown, Dark Brown Bronze, Claystone Grey, Charcoal Grey | <ul style="list-style-type: none"> Dual Fin PVC seals against the door Third Fin seals the gap between the product and the jamb Includes Cap to Hide Screws |
| SR-1405E |  | 7', 8', 9', 10', 14', 16' | 12 | Rigid PVC/ Flexible PVC (Co-Extruded) | White, Sandstone Cream, Brown, Bronze, Black, Grey | <ul style="list-style-type: none"> Economical Works on gradual arches Nail or Screw in |
| SR-1404 |  | 7', 8', 9', 10', 12', 16', 18' | 9 | Rigid PVC/ Flexible PVC (Co-Extruded) | White, Sandstone Cream, Brown, Bronze, Black | <ul style="list-style-type: none"> Extra Wide Profile Flexible co-extruded cap to hide screws Dual Fin PVC seals against the door |

Side and top Rigid PVC, Reverse angle

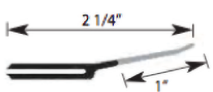
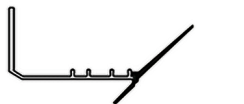
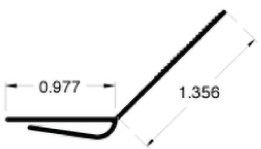
| Model | Image | Length | Box Quantity | Material | Colours | Description |
|---------|---|---------------------------|-------------------|---|--|--|
| SR-9001 |  | 24' | 25 | Rigid PVC/ Flexible PVC (Co-Extruded) | Grey Rigid PVC, Black Flexible PVC | <ul style="list-style-type: none"> Reverse Angle Clip-On PVC Clips onto reverse angle Clips Overtop of 1/4" Angle |
| SR-9002 |  | 24' | 25 | Rigid PVC/ Flexible PVC (Co-Extruded) | Black Rigid PVC, Black Flexible PVC | <ul style="list-style-type: none"> Reverse Angle Clip-On PVC Side Use – Clips onto Reverse Angle Also for Residential Use |
| SR-9003 |  | 9', 11', 13', 15', 17' | 20 | Rigid PVC/ Flexible PVC (Co-Extruded) | Black | <ul style="list-style-type: none"> Available for 2" or 3" Reverse Angle Bolts onto Reverse Angle Steel Jamb |
| SR-9004 |  | 200' Per Spool | 200' Per Spool | Rigid PVC/ Flexible PVC (Co-Extruded) | White, Brown, Grey, Black | <ul style="list-style-type: none"> Reverse Angle Clip-On Vinyl Side Use – Clips onto Steel Jamb Also for Residential Use |

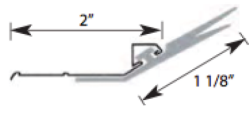

Side and top Steel

| Model | Image | Length | Box Quantity | Material | Colours | Description |
|---------|---|--------------------|--------------|---------------------------------|--|--|
| SS-7001 |  | 7', 8', 9', 10' | 20 | Galvanized Steel / Flexible PVC | Laminated Cherry Oak, Laminated Dark Oak, Laminated Medium Oak, White, Sandstone, Cream, Charcoal Grey, Brown, Bronze, Black | <ul style="list-style-type: none"> • Steel is Notched on Both Ends for Easier Installation • Third Fin seals the gap between the product and the jamb • Economical • Dual Fin PVC seals against the door |
| | | 12', 14', 16', 18' | 10 | | | |

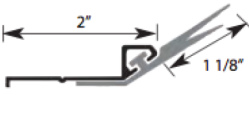
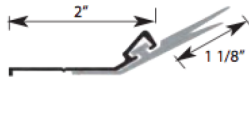
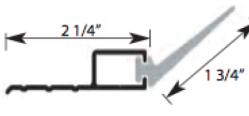
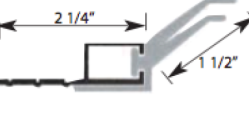
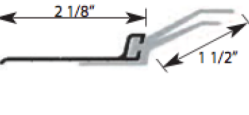

Side and top Aluminum

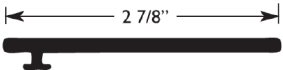
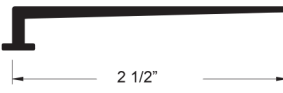
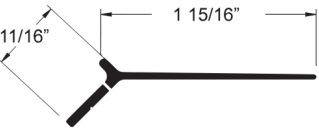
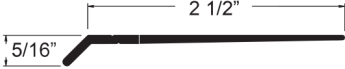
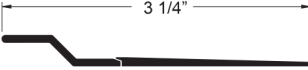
| Model | Image | Length | Box Quantity | Material | Colours | Description |
|---------|---|--------------------------------------|--------------|-------------------------|--|--|
| SA-5001 |  | 7', 8', 9', 10', 12', 14', 16', 18' | 20 | Aluminum / Flexible PVC | White, Sandstone, Cream, Brown, Black, Dark Brown, Charcoal Grey, Laminated Cherry Oak, Laminated Dark Oak, Laminated Medium Oak, Iron Ore | <ul style="list-style-type: none"> • Painted Aluminum retainer • Dual Fin PVC seals against the door • Third Fin seals the gap between the product and the jamb • Great for residential applications |
| SA-1001 |  | 8', 9', 10', 12', 14', 16', 18', 24' | 10 | Aluminum / Flexible PVC | Mill Finish Aluminum, Black Flexible PVC | <ul style="list-style-type: none"> • Aluminum retainer • Dual Fin PVC seals against the door • Third Fin seals the gap between the product and the jamb |
| SA-1101 |  | 8', 10', 12', 14', 16', 24' | 10 | Aluminum / Flexible PVC | Mill Finish Aluminum, Black Flexible PVC | <ul style="list-style-type: none"> • Aluminum Retainer • Heavy Duty Single-Fin PVC |
| SA-1102 |  | 8', 10', 12', 14', 16', 18', 24' | 8 | Aluminum / Flexible PVC | Mill Finish Aluminum, Black Flexible PVC | <ul style="list-style-type: none"> • Heavy Duty Dual Fin PVC • Third Fin seals the gap between the product and the jamb • Aluminum Retainer • Specifically For Colder Climates |
| SA-1106 |  | 8', 10', 12', 14', 16', 18', 24' | 15 | Aluminum / Flexible PVC | Mill Finish Aluminum, Black Flexible PVC | <ul style="list-style-type: none"> • Aluminum retainer • Dual Fin PVC seals against the door • Third Fin seals the gap between the product and the jamb |
| | | | | | Anodized Aluminum, Black Flexible PVC | |

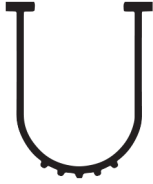

Top seal

| Model | Image | Roll / Length | Material | Colours | Description |
|--------|---|------------------------------|--|---------|--|
| TS-300 |  | 150' per roll | Flexible Vinyl | Black | <ul style="list-style-type: none"> • Slides into standard 'U' shape retainer BR-1006 • Installed on top sections |
| TS-238 |  | 200' per roll | Flexible Vinyl | Black | <ul style="list-style-type: none"> • Slides into standard 'U' shape retainer BR-1006 • Installed on top sections |
| TS-534 |  | 100' per roll | Rigid Vinyl / Flexible Vinyl (Co-Extruded) | Black | <ul style="list-style-type: none"> • Installs on top sections • Offers additional draft Seal |
| TS-515 |  | 150' per box (3 x 50' coils) | Rigid Vinyl / Flexible Vinyl (Co-Extruded) | Black | <ul style="list-style-type: none"> • Installs on top sections • Offers additional draft Seal |
| TS-320 |  | 150' per box (3 x 50' coils) | Rigid Vinyl / Flexible Vinyl (Co-Extruded) | Black | <ul style="list-style-type: none"> • Installs on top sections • Offers additional draft Seal |
| TS-319 |  | 150' per box (3 x 50' coils) | Rigid Vinyl / Flexible Vinyl (Co-Extruded) | Black | <ul style="list-style-type: none"> • Installs on top sections • Offers additional draft Seal |

Bottom 'U' rubber (PVC)

| Model | Image | Roll / Length | Description |
|-----------------|---|---------------|--|
| V1003 - 3" |  | 200' Roll | <ul style="list-style-type: none"> • Flexible PVC, 3" Width • Compatible with ELTON's plastic and aluminum bottom retainers • Available in Black or Yellow |
| V1003 - 4" | | 200' Roll | <ul style="list-style-type: none"> • Flexible PVC, 4" Width • Compatible with ELTON's plastic and aluminum bottom retainers • Available in Black or Yellow |
| V1003 - 5" | | 150' Roll | <ul style="list-style-type: none"> • Flexible PVC, 5" Width • Compatible with ELTON's plastic and aluminum bottom retainers • Available in Black or Yellow |
| V1003 - 6.5" | | 100' Roll | <ul style="list-style-type: none"> • Flexible PVC, 6.5" Width • Compatible with ELTON's plastic and aluminum bottom retainers • Available in Black or Yellow |
| V1003-3-DF |  | 200' Roll | <ul style="list-style-type: none"> • Flexible PVC, 3" Width • Compatible with ELTON's plastic and aluminum bottom retainers • U-Shape seal with added Drip Edge • Available in Black |
| V1003-4-DF | | 200' Roll | <ul style="list-style-type: none"> • Flexible PVC, 4" Width • Compatible with ELTON's plastic and aluminum bottom retainers • U-Shape seal with added Drip Edge • Available in Black |
| V1003-3-R-BLOCK |  | 75' Per Roll | <ul style="list-style-type: none"> • Compatible with ELTON's plastic and aluminum bottom retainers • Highly effective at keeping pests out of places they don't belong • Available in Black, 3" Width |
| V1003-4-R-BLOCK | | 75' Per Roll | <ul style="list-style-type: none"> • Compatible with ELTON's plastic and aluminum bottom retainers • Highly effective at keeping pests out of places they don't belong • Available in Black, 4" Width |

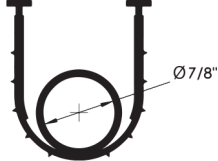
Thermoplastic Rubber (TPR) Superior Weather Performance

| Model | Image | Roll / Length | Description |
|-------------|---|---------------|---|
| V1003-444 |  | Coil | <ul style="list-style-type: none"> • TPR • 4" Width • Compatible with ELTON's plastic and aluminum bottom retainers • Used as an improved bottom seal or as a safety edge • Available in Black • Plugs also available |
| V1003-TPR-3 |  | 200' Roll | <ul style="list-style-type: none"> • TPR, 3" Width • Compatible with ELTON's plastic and aluminum bottom retainers • Available in Black |
| V1003-TPR-4 | | 200' Roll | <ul style="list-style-type: none"> • TPR, 4" Width • Compatible with ELTON's plastic and aluminum bottom retainers • Available in Black |

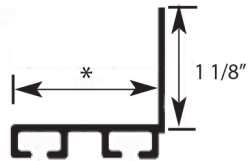
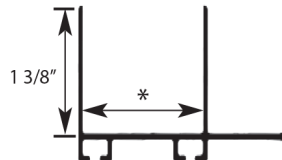
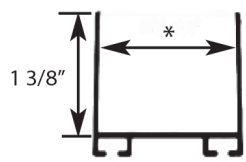
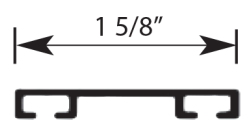
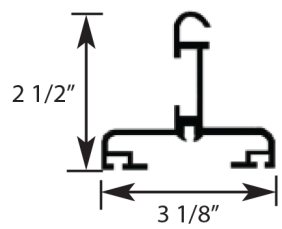
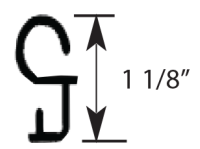

Bottom retainers

Aluminum

| Model | Image | Length | Description |
|-----------|---|--------------------------------|---|
| BA-1003 |  | 8', 10', 12', 14', 16', 24' | * For door thickness: 1-3/8", 1-5/8", 2" |
| BA-1004 |  | 24' | * For door thickness: 1-3/4", 2" |
| BA-1005 |  | 8', 10', 12', 14', 16', 24' | * For door thickness: 1-3/8", 1-1/2", 1-3/4", 2" |
| BA-1007 |  | 8', 10', 12', 14', 16', 24' | * For door thickness: 1-5/8" |
| BA-3011 |  | 25' | * For rolling steel door |
| BA-3011-1 |  | 25' | Flat Slat Adapter |

Bottom retainers

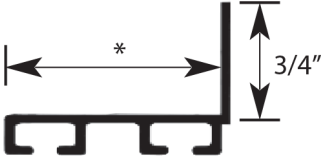
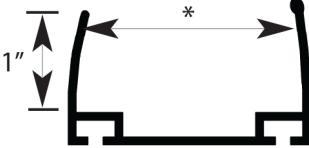
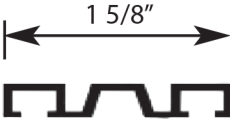
Rigid PVC

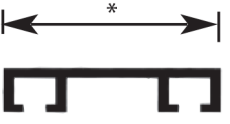
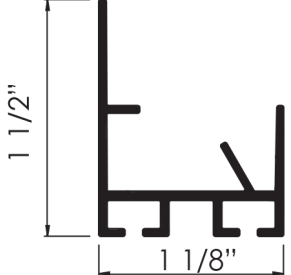
| Model | Image | Length | Description |
|---------|---|------------------------------------|--|
| BR-1013 |  | 8', 10', 12' 14', 16', 24' | (Black) * For door thickness: 1-1/4", 1-3/8", 2" * Packaged 40 / Bag |
| BR-1006 |  | 8', 10', 12' 14', 16', 24' | (Black) With flexible fin to touch door face * For door thickness: 1-3/8", 1-1/2", 1-3/4", 2" * Packaged 16 / Bag |
| BR-1014 |  | 8', 10', 12' 14', 16', 24' | (Black) * For door thickness: 1-5/8" * Packaged 40 / Bag |
| BR-1015 |  | 8', 9', 10', 12', 14', 16', 24' | (Black) * For door thickness: 1-3/4" 8' and 9' - Packaged 50 / Bag 10', 12', 14', 16', 24' Packaged 25 / Bag |
| BR-1019 |  | 8', 10', 12' 14', 16', 24' | (Black) * For door thickness: 1-3/8", 2" * Packaged 32 / Bag |
| BR-599 |  | 10', 16' | (Black) * For door thickness: 1-1/8" * 10' - Packaged 20 pcs / Bag * 16' - Packaged 25 pcs / Bag |

Brush Seals

| Standard Brush | |
|----------------|----------------|
| Model | Bristle Width |
| RL-100 | 1" Bristle |
| RL-138 | 1 3/8" Bristle |
| RL-112 | 1 1/2" Bristle |
| RL-200 | 2" Bristle |
| RL-300 | 3" Bristle |
| RL-400 | 4" Bristle |
| RL-600 | 6" Bristle |

Standard Brush Comes in 6' Lengths

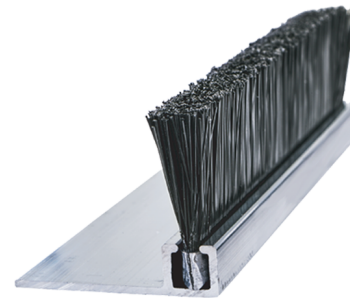

| Heavy Brush | |
|-------------|---------------|
| Model | Bristle Width |
| RH-300 | 3" Bristle |
| RH-600 | 6" Bristle |

Heavy Brush Comes in 8' Lengths

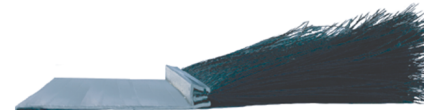

| Viny Insert RV | | |
|----------------|--------------------|---------------|
| Model | Vinyl Width | Spool Lengths |
| RV-100 | 1" Vinyl Width | 600' |
| RV-112 | 1 1/2" Vinyl Width | 400' |
| RV-200 | 2" Vinyl Width | 300' |
| RV-300 | 3" Vinyl Width | 200' |

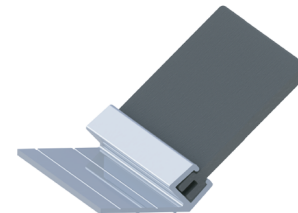

| Dock Brush Kits | |
|--------------------------------|--------------------------------|
| 1" Brush Kits | 1 1/2" Brush Kits |
| • KIT5100S - For 6' Dock Plate | • KIT5112S - For 6' Dock Plate |
| • KIT7100S - For 8' Dock Plate | • KIT7112S - For 8' Dock Plate |

| Dock Brush Kits - Weldable Options | |
|------------------------------------|--------------------------------|
| 1" Brush Kits | 1 1/2" Brush Kits |
| • KIT5100W - For 6' Dock Plate | • KIT5112W - For 6' Dock Plate |
| • KIT7100W - For 8' Dock Plate | • KIT7112W - For 8' Dock Plate |

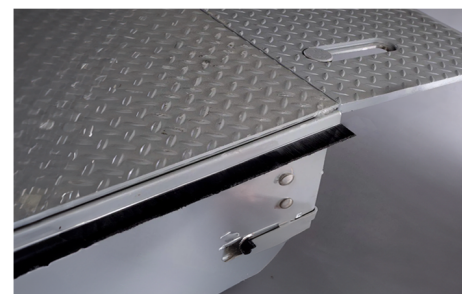





Dock Brush Kits Include:

- 2 Pieces of RA4007, 1-1/4" 90° Retainer
- 2 Pieces of 1" **OR** 1-1/2" Standard Brush Seal
- Self Tapping Fasteners
- Pre Cut to 5' Lengths for 6' docks 7' lengths for 8' docks

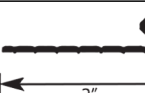
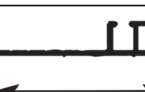
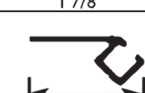
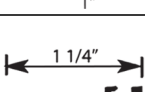
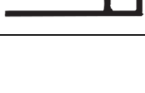
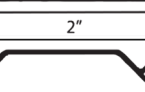
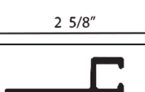
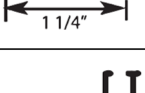
Optional Weldable Bracket
 Brush Kit Available in 1" and 1-1/2"
 For Additional Bristle Length Please Contact for More Information

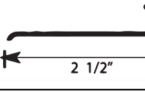
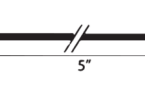
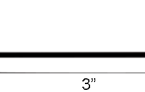

Retainers for Brush Seal

| Model | Image | Available Lengths | Material |
|---------------------------------|---|----------------------------|--|
| Standard Brush Retainers | | | |
| RA-4001 |  | 6', 8', 10', 12', 14', 16' | Aluminum Retainer <ul style="list-style-type: none"> For Angle Application (45°) For use with Standard brush or vinyl insert |
| RA-4002 |  | 6', 8', 10', 12', 14', 16' | Aluminum Retainer <ul style="list-style-type: none"> For Angle Application (45°) For use with Standard brush or vinyl insert |
| RA-4003 |  | 6', 8', 12', 16' | Aluminum Retainer <ul style="list-style-type: none"> For Angle Application (90° & 80°) For use with Standard brush or vinyl insert |
| RA-4006 |  | 6', 12' | Aluminum Retainer <ul style="list-style-type: none"> For Angle Application (45°) For use with Standard brush or vinyl insert |
| RA-4007 |  | 6', 8', 10', 12', 14', 16' | Aluminum Retainer <ul style="list-style-type: none"> For Angle Application (90°) For use with Standard brush or vinyl insert |
| RA-4008 |  | 6', 12' | Aluminum Retainer <ul style="list-style-type: none"> 2" Off Set For use with Standard brush or vinyl insert |
| RA-4009 |  | 12' | Aluminum Retainer <ul style="list-style-type: none"> For Reverse Angle Rolling Steel Doors For use with Standard brush or vinyl insert |
| RA-4010 |  | 6', 8', 10', 12', 14', 16' | Aluminum Retainer <ul style="list-style-type: none"> For Angle Application (180°) For use with Standard brush or vinyl insert |
| RA-4011 |  | 12' | Aluminum Retainer <ul style="list-style-type: none"> For Angle Application (90° Double Track) For use with Standard brush or vinyl insert |
| Heavy Brush Retainers | | | |
| RA-4004 |  | 8', 16' | Aluminum Retainer <ul style="list-style-type: none"> For Angle Application (45°) For use with Heavy brush |
| RA-4005 |  | 8', 16' | Aluminum Retainer <ul style="list-style-type: none"> For Angle Application (180°) For use with Heavy brush |
| RA-4012 |  | 8', 16' | Aluminum Retainer <ul style="list-style-type: none"> For Angle Application (90°) For use with Heavy brush |
| Dock Leveler Retainers | | | |
| RA-4007 |  | 6', 8', 10', 12', 14', 16' | Aluminum Retainer <ul style="list-style-type: none"> For Angle Application (90°) For use with Standard brush or vinyl insert |
| DL-4000 |  | 6', 8' | Galvanized Steel Retainer <ul style="list-style-type: none"> Weldable to sides of Dock Leveler RA-4007 aluminum retainer & Standard brush insert slides into this outer retainer |

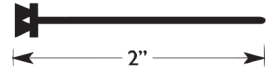
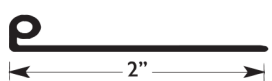

Threshold, replacement sweeps

| Model | Image | Roll / Length | Description |
|---------|---|--|--|
| V1016-0 |  | <ul style="list-style-type: none"> • 100' Per Roll • Threshold (Including Adhesive) • Vinyl Colour: Black | <ul style="list-style-type: none"> • Threshold • Installed on the ground below garage door as a second seal to prevent water from flowing into the garage • Can be driven over with vehicle |
| V1010 |  | <ul style="list-style-type: none"> • 300' Per Roll • Vinyl Colour: Grey | <ul style="list-style-type: none"> • Replacement sweep for One-Piece Door • Fits into the bottom of One-Piece Stanley™ doors |
| V1011 |  | <ul style="list-style-type: none"> • 200' Per Roll • Vinyl Colour: Grey | <ul style="list-style-type: none"> • Replacement sweep for One-Piece Door • Fits into the bottom of One-Piece Taylor™ doors |

Hoses

| Model | Image | Description | Roll / Length |
|--------|---|---|---------------|
| 3001-0 |  | <ul style="list-style-type: none"> • TPR • Signal Tube • ID = 3/8" | 250' Per Roll |
| 3002-0 |  | <ul style="list-style-type: none"> • TPR • Gum Hose • ID = 1/2" • Installed in Bottom "U" Rubber for use as Safety Edge | 200' Per Roll |

Handles, exhaust port

| Image | Model | Material | Colour | Cut-out Size | Description |
|---|-----------|--------------|--------|-----------------|--|
|  | AR-3007-0 | Polyethylene | Black | 6-3/8" x 3-5/8" | <ul style="list-style-type: none"> • Telescopic Door Handle • For Door Thickness 1-3/8" – 2" |
|  | AR-3007-1 | Polyethylene | Black | 6-3/8" x 3-5/8" | <ul style="list-style-type: none"> • Telescopic Door Handle • For Door Thickness 1-3/8" – 2" |
|  | 3009-1-B | Polyethylene | Black | 4.5" Diameter | <ul style="list-style-type: none"> • Exhaust Port • For Any Door Thickness |

Spring filler, operator clip

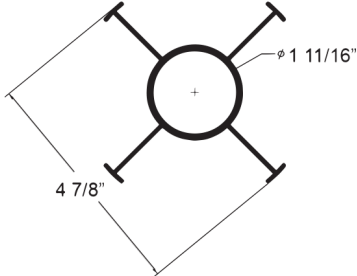
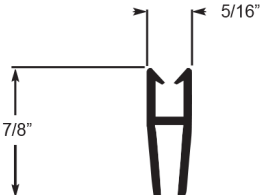
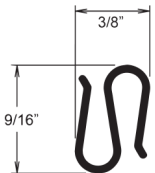
| Model | Image | Description | Roll / Length |
|----------------|---|---|---------------|
| SPRBLK414 |  | <p>Spring Filler</p> <ul style="list-style-type: none"> • For use with 5-1/4" or 6" springs • 1-3/8" ID | 12' per piece |
| SPRINGBLOCK478 |  | <p>Spring Filler</p> <ul style="list-style-type: none"> • For use with 5-1/4" or 6" springs • 1-11/16" ID | 12' per piece |
| AA-0429 |  | <p>Operator Rail Clip / Wire Manager</p> <ul style="list-style-type: none"> • 100 per box • Liftmaster™ T-Rail • Black | 5' per piece |
| AA-516 |  | <p>Operator Rail Clip / Wire Manager</p> <ul style="list-style-type: none"> • 150 per box • Black | 5' per piece |

Nail on for wood door

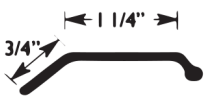
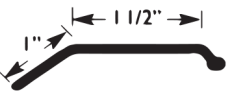
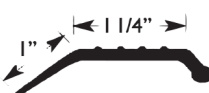
| Model | Image | Roll / Length | Description |
|---------|---|--|--|
| V1008 |  | <ul style="list-style-type: none"> • 250' Per Roll • Vinyl Colour: Black | <ul style="list-style-type: none"> • Bottom Nail-on for Wood Door • For 1-3/8" Doors • Light Duty |
| V1009 |  | <ul style="list-style-type: none"> • 200' Per Roll • Vinyl Colour: Black | <ul style="list-style-type: none"> • Bottom Nail-on for Wood Door • For 1-3/4" Doors • Heavy Duty |
| V1009-1 |  | <ul style="list-style-type: none"> • 150' Per Roll • Vinyl Colour: Black | <ul style="list-style-type: none"> • Bottom Nail-on for Wood Door • For 1-3/8" Doors • For Heavier Applications than V1009 • Provides Better Cushion |

Commercial windows

Glass Options

Most glass options can be ordered as single pane or insulated units

| Stock Glass | Special Glass |
|---|---|
| <ul style="list-style-type: none"> • Double strength (Annealed/Float) glass - 3mm (1/8") • Tempered • Tinted | <ul style="list-style-type: none"> • Polished Georgian Wire • Low-E • Breather Tubes • Laminate • Argon Filled • Reflective |

Frames For Insulated Doors

Elton's injection molded frames deliver the best in quality and appearance for your commercial door. The unique, screw-together design makes installation simple – and our polypropylene frames will not discolor! Please see the chart below for specifications, colors, glass options and door thicknesses.

0120

Screw-Together Window



| Model | Frame Size (tip-to-tip) | Cut-out Size | Vision Area | | | | | |
|--------------|-------------------------------|--------------------|--------------------------|--------|--------|--------|----|----|
| 0120 | 12 15/16" Outside Diameter | 11 15/16" Diameter | 10 3/16" Inside Diameter | | | | | |
| | 328mm Outside Diameter | 303mm Diameter | 274mm Inside Diameter | | | | | |
| Frame Colour | Glass Options | Box Quantity | | | | | | |
| | | PAN | 1 3/8" | 1 1/2" | 1 5/8" | 1 3/4" | 2" | FO |
| Black, White | Sealed Plexi, Sealed Lexan | N/A | N/A | 16 | 16 | 12 | 12 | 16 |

0624

Screw-Together Window



| Model | Frame Size (tip-to-tip) | Cut-out Size | Vision Area | | | | | |
|--|-----------------------------|-------------------|------------------|--------|--------|--------|----|----|
| 0624 | 23 13/16" x 5 11/16" | 23 1/16" x 4 7/8" | 21 1/4" x 3 1/4" | | | | | |
| | 605mm x 144mm | 586mm x 124mm | 541mm x 82mm | | | | | |
| Frame Colour | Glass Options | Box Quantity | | | | | | |
| | | PAN | 1 3/8" | 1 1/2" | 1 5/8" | 1 3/4" | 2" | FO |
| Black, White, Cream, Sandstone, Brown, Grey | See chart for glass options | 24 | 18 | 16 | 16 | 16 | 14 | 18 |

0824

Screw-Together Window



| Model | Frame Size (tip-to-tip) | Cut-out Size | Vision Area | | | | | | |
|--|-----------------------------|------------------|-------------------|--------|--------|--------|----|----|----|
| 0824 | 24" x 8" | 23 1/8" x 7 1/8" | 21 9/16" x 5 1/2" | | | | | | |
| | 610mm x 203mm | 583mm x 181mm | 547mm x 140mm | | | | | | |
| Frame Colour | Glass Options | Box Quantity | | | | | | | |
| | | PAN | 1 3/8" | 1 1/2" | 1 5/8" | 1 3/4" | 2" | 3" | FO |
| Black, White, Cream, Sandstone, Brown, Grey | See chart for glass options | N/A | 12 | 12 | 12 | 12 | 10 | 8 | 13 |

Copyright © 2024 Elton Manufacturing

Elton Manufacturing 1-800-297-8299 :: sales@eltonmanufacturing.com :: www.eltonmanufacturing.com

Commercial windows

1224

For flush doors
Screw-Together Window



| Model | Frame Size (tip-to-tip) | Cut-out Size | Vision Area |
|-------|-------------------------|---------------------|-------------------|
| 1224 | 25" 1/16" x 13 1/16" | 23 7/8" x 11 15/16" | 21 1/2" x 9 9/16" |
| | 637mm x 332mm | 606mm x 303mm | 546mm x 243mm |

| Frame Colour | Glass Options | Available door Thickness / Box Quantity | | | | | | | |
|---|-----------------------------|---|--------|--------|--------|--------|----|----|----|
| | | PAN | 1 3/8" | 1 1/2" | 1 5/8" | 1 3/4" | 2" | 3" | FO |
| Black, White, Cream, Sandstone, Brown, Grey | See chart for glass options | N/A | 8 | 6 | 6 | 6 | 6 | 4 | 8 |

1225

For Ribbed doors
Screw-Together Window

Frames For Deep Ribbed Pan Door

1225 will fit most door manufacturers' ribbed panels. The tabs on our 1225 frame fit right into the deep ribs of the door. This saves installation time, as there's no need to fill the ribs with caulking. The interior frame for a pan door is designed to go right over the deep ribs perfectly, lining up the screw holes with the exterior frame. You can mix and match 1224 & 1225 to fit ribbed or flush sections for pan or insulated doors.

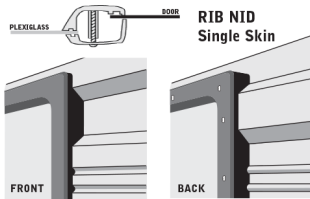

| Model | Frame Size (tip-to-tip) | Cut-out Size | Vision Area |
|-------|-------------------------|---------------------|-------------------|
| 1225 | 25" x 13" | 23 3/4" x 11 13/16" | 21 1/2" x 9 9/16" |
| | 635mm x 330mm | 603mm x 300mm | 546mm x 243mm |

| Frame Colour | Glass Options | Box Quantity | | | | | | | |
|---|-----------------------------|--------------|--------|--------|--------|--------|----|----|----|
| | | PAN | 1 3/8" | 1 1/2" | 1 5/8" | 1 3/4" | 2" | 3" | FO |
| Black, White, Cream, Sandstone, Brown, Grey | See chart for glass options | 15 | 8 | 8 | 6 | 6 | 6 | 6 | 10 |

1326

Screw-Together Window



| Model | Frame Size (tip-to-tip) | Cut-out Size | Vision Area |
|-------|-------------------------|---------------------|---|
| 1326 | 26 1/8" x 13 9/16" | 25 1/16" x 12 9/16" | 23 7/16" x 10 13/16" Corner Cut 4" Radius |
| | 663mm x 344mm | 637mm x 319mm | 595mm x 275mm Corner Cut 101.60mm Radius |

| Frame Colour | Glass Options | Box Quantity | | | | | | | |
|--------------|----------------------------|--------------|----|--------|--------|--------|--------|----|----|
| | | PAN | 1" | 1 3/8" | 1 1/2" | 1 5/8" | 1 3/4" | 2" | FO |
| Black, White | Sealed Plexi, Sealed Lexan | N/A | 8 | 8 | 8 | 8 | 6 | 6 | 8 |

*1326 Cut-out is oval. Please call us for template.

1634

Screw-Together Window



| Model | Frame Size (tip-to-tip) | Cut-out Size | Vision Area |
|-------|-------------------------|-------------------|---------------------|
| 1634 | 35 1/8" x 17 1/8" | 33 7/8" x 15 7/8" | 31 3/4" x 13 11/16" |
| | 892mm x 435mm | 861mm x 403mm | 806mm x 348mm |

| Frame Colour | Glass Options | Box Quantity | | | | | | | |
|---|-----------------------------|--------------|--------|--------|--------|--------|----|----|----|
| | | PAN | 1 3/8" | 1 1/2" | 1 5/8" | 1 3/4" | 2" | 3" | FO |
| Black, White, Cream, Sandstone, Brown, Grey | See chart for glass options | N/A | 4 | 4 | 4 | 4 | 4 | 3 | 6 |

Commercial windows

1324

Screw-Together Window



| Model | Frame Size (tip-to-tip) | Cut-out Size | Vision Area | | | | | |
|---|-----------------------------|-------------------|--------------------|--------|--------|--------|----|----|
| 1324 | 26 3/4" x 14 1/2" | 25 5/8" x 13 3/8" | 23 7/8" x 11 9/16" | | | | | |
| | 679mm x 369mm | 651mm x 340mm | 606mm x 294mm | | | | | |
| Frame Colour | Glass Options | Box Quantity | | | | | | |
| | | PAN | 1 3/8" | 1 1/2" | 1 5/8" | 1 3/4" | 2" | FO |
| Black, White, Cream, Sandstone, Brown, Grey | See chart for glass options | N/A | 8 | 8 | 6 | 6 | 6 | 8 |

1325

Clip-Together Window



| Model | Frame Size (tip-to-tip) | Cut-out Size | Vision Area | | | | | |
|--------------|----------------------------|-------------------|--------------------|--------|--------|--------|-----|-----|
| 1325 | 26 3/4" x 14 1/2" | 25 5/8" x 13 1/2" | 23 7/8" x 11 9/16" | | | | | |
| | 679mm x 369mm | 651mm x 340mm | 606mm x 294mm | | | | | |
| Frame Colour | Glass Options | Box Quantity | | | | | | |
| | | PAN | 1 3/8" | 1 1/2" | 1 5/8" | 1 3/4" | 2" | FO |
| Black | Sealed Plexi, Sealed Lexan | N/A | N/A | 8 | 8 | N/A | N/A | N/A |

1328

Clip-Together Window



| Model | Frame Size (tip-to-tip) | Cut-out Size | Vision Area | | | | | |
|--------------|----------------------------|-------------------|--|--------|--------|--------|-----|-----|
| 1328 | 28 9/16" x 12 13/16" | 27 3/8" x 11 3/4" | 25 5/8" x 9 7/8" Corner Cut 2 3/4" Radius | | | | | |
| | 725mm x 325mm | 695mm x 298mm | 651mm x 251mm Corner Cut 69.85mm Radius | | | | | |
| Frame Colour | Glass Options | Box Quantity | | | | | | |
| | | PAN | 1 3/8" | 1 1/2" | 1 5/8" | 1 3/4" | 2" | FO |
| Black | Sealed Plexi, Sealed Lexan | N/A | N/A | 8 | 8 | N/A | N/A | N/A |

*1328 Cut-out is oval. Please call us for template.

Garage door ventilation

Louver

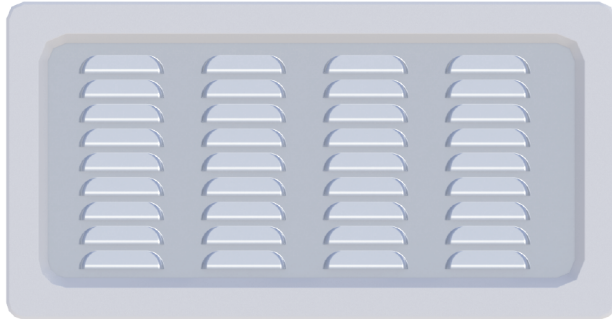

- Powder coated white for Durability
- Screen Keeps Bugs out
- Fits virtually any window size

* Standard size: Elton 1224
* Number of louver rows depends on window size
* Please call us for more information on custom sizes

Slider

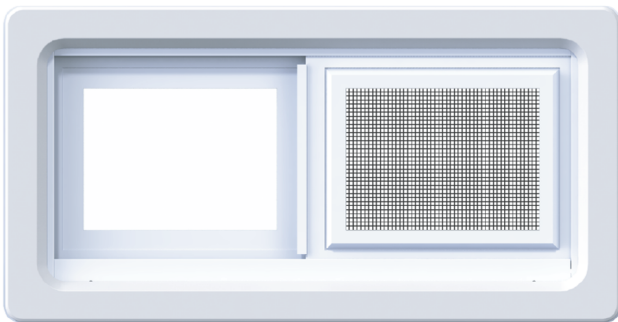

- Controls air flow for all seasons
- Screened Sliding Window allows for ventilation and keeps insects out
- Fits into standard Elton 1224 Commercial Window frame
- Available for 2" door panels

* Standard size: Elton 1224
* Single glass only

Expanded aluminum

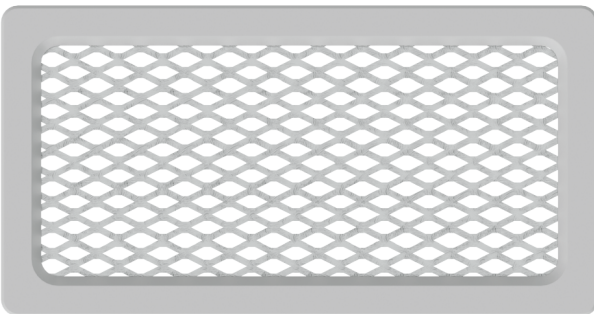

- Ideal for underground garages
- Mill finish aluminum
- Flattened diamond pattern
- Fits virtually any window size

* Standard size: Elton 1224
* Please call us for more information on custom sizes



Providing Over
40 Years of Product Innovation



Classic Elegance

ENDLESS
POSSIBILITIES
The "Stackable Series"

Newly Designed EP Frames

Elton's new **Stackable Series** introduces a fresh, modern design to any garage door. With a sleek, stylish smooth profile, it's a revolution in garage decor, blending form and function to cater to Endless Possibilities

Highlights

- ✓ Injection Moulded
- ✓ Colors: Black, White, Tan (Paintable)
- ✓ Available for 1 3/4" & 2" Door Thickness
- ✓ Smooth Profile
- ✓ Stylish Look With Flexibility
- ✓ Offered in 4 Sizes

| Sizes | |
|----------|--------------------|
| Model | Outside Dimensions |
| 8" x 48" | 10" x 50" |
| 8" x 36" | 10" x 38" |
| 8" x 22" | 10" x 24" |
| 7" x 64" | 9" x 66" |



Shown in 7 x 64 (9" x 66" O.D.)

Copyright © 2024 Elton Manufacturing
Elton Manufacturing 1-800-297-8299 :: sales@eltonmanufacturing.com :: www.eltonmanufacturing.com

Residential windows

| Short Panel | | | | | | |
|-------------|-----------------|-----------------------------------|-------------|----------------------------|----------------------|----------------------|
| Model | Snap-In Inserts | Available for Non Insulated Doors | Measurement | Outside Frame (Tip to Tip) | Cut - Out Size | Vision Area |
| 1319 | - | √ | Imperial | 19 1/7" x 12 3/4" | 18 5/16" x 11 13/16" | 16 11/16" x 10 3/16" |
| | | | Metric | 488mm x 323mm | 464mm x 300mm | 423mm x 259mm |
| 1419 | √ | √ | Imperial | 19 3/4" x 14 7/16" | 19 1/8" x 13 13/16" | 16 3/4" x 11 5/8" |
| | | | Metric | 502mm x 367mm | 485mm x 350mm | 426mm x 296mm |
| 1420 | √ | √ | Imperial | 19 1/2" x 14 5/16" | 18 3/4" x 13 5/8" | 16 15/16" x 11 |
| | | | Metric | 495mm x 363mm | 477mm x 344mm | 430mm x 295mm |
| 1520 | √ | √ | Imperial | 20 9/16" x 15 7/16" | 19 1/2" x 14 3/8" | 16 3/4" x 11 5/8" |
| | | | Metric | 522mm x 392mm | 495mm x 365mm | 426mm x 295mm |
| 1622 | - | √ | Imperial | 21 1/8" x 15 11/16" | 20 1/4" x 14 3/16" | 18 5/8" x 13 3/16" |
| | | | Metric | 537mm x 378mm | 473mm x 354mm | 515mm x 376mm |

| Intermediate Panel | | | | | | |
|--------------------|-----------------|-----------------------------------|-------------|----------------------------|-------------------|----------------------|
| Model | Snap-In Inserts | Available for Non Insulated Doors | Measurement | Outside Frame (Tip to Tip) | Cut - Out Size | Vision Area |
| 1427 | √ | - | Imperial | 26 1/2" x 14 5/8" | 25 1/2" x 13 3/8" | 23 15/16" x 11 9/16" |
| | | | Metric | 673mm x 371.5mm | 648mm x 340mm | 608mm x 294mm |

| Long Panel | | | | | | |
|------------|-----------------|-----------------------------------|-------------|----------------------------|-----------------------|---------------------|
| Model | Snap-In Inserts | Available for Non Insulated Doors | Measurement | Outside Frame (Tip to Tip) | Cut - Out Size | Vision Area |
| 741 | - | - | Imperial | 40 7/8" x 7 15/16" | 40 1/16" x 6 1/8" | 38" x 4" |
| | | | Metric | 1038mm x 202mm | 1018mm x 156mm | 965mm x 102mm |
| 1542 | √ | √ | Imperial | 42 15/16" x 15 3/4" | 42 1/16" x 14 3/16" | 40" x 12 7/8" |
| | | | Metric | 1090mm x 400mm | 1068mm x 376mm | 1016mm x 327mm |
| 1440 | √ | √ | Imperial | 42 5/16" x 14 1/4" | 41 11/16" x 13 11/16" | 39 11/16" x 11 5/8" |
| | | | Metric | 1075mm x 364mm | 1059mm x 348mm | 1008mm x 295mm |

| * Non-Stock Item. Please call for custom run details. | | | | | | |
|---|-----------------|-----------------------------------|-------------|----------------------------|----------------------|---------------------|
| Model | Snap-In Inserts | Available for Non Insulated Doors | Measurement | Outside Frame (Tip to Tip) | Cut - Out Size | Vision Area |
| 1421 | - | √ | Imperial | 21" x 13 9/16" | 20 1/16" x 12 11/16" | 18 1/4" x 10 13/16" |
| | | | Metric | 533mm x 344mm | 510mm x 322mm | 464mm x 275mm |
| 1521 | - | - | Imperial | 20 3/4" x 14 7/8" | 19 7/8" x 13 15/16" | 17 7/8" x 12" |
| | | | Metric | 527mm x 378mm | 505mm x 354mm | 454mm x 304mm |

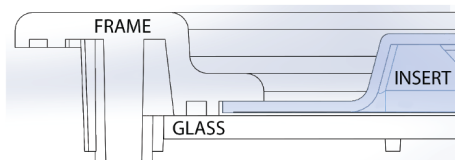

• Snap-in-insert from front of frame with glass sealed to frame

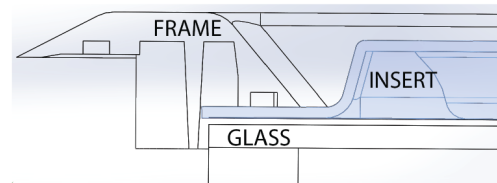

• Lay-in-insert from front of frame with insert sealed to frame

Residential inserts Short panel

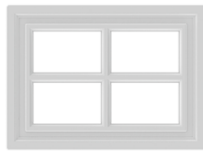

Stockton

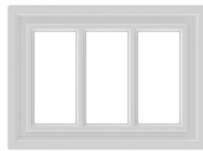

Stockbridge

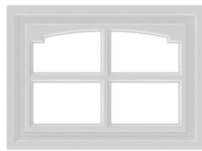

Cascade

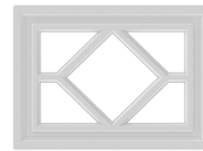

Waterton



Prairie

Long Panel



4 Square Stockton



8 Square Stockton



10 Square Stockton



Straight Stockbridge



Cascade

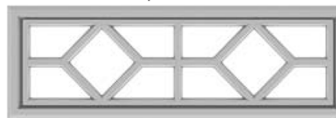

Waterton



Prairie

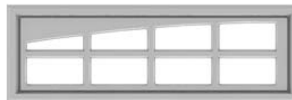

2 Piece Arched Stockton

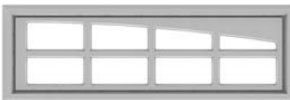

2 Piece Arched Stockbridge

Residential inserts Intermediate panel



1 Piece Wagon Wheel

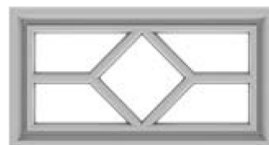

Waterton

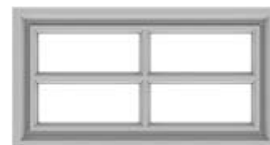

Stockton

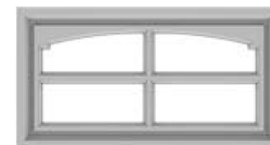

Cascade

**** Inserts May Not Ship Exactly As Shown ****

Celebrating Over 40 Years



1265 Aerowood Drive
Mississauga, ON L4W 1B9
800-297-8299
sales@eltonmanufacturing.com