



Elton
MANUFACTURING

SPRING 26

CELEBRATING
45 YEARS OF EXCELLENCE



QUALITY | INNOVATION | TRUST

SEALS AND ACCESSORIES

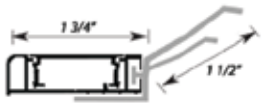
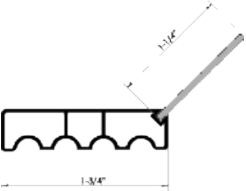
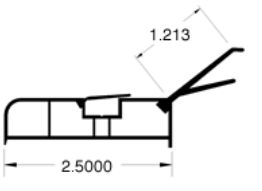
Side and Top Rigid PVC

Model	Image	Length	Box Quantity	Material	Colours	Description
SR-1104		7', 8', 9', 10', 12', 14', 16', 18'	12	Rigid PVC/ Flexible PVC	White, Black, Cream, Dark Sandstone Desert Sand, Brown, Dark Brown Bronze, Claystone Grey, Charcoal Grey	<ul style="list-style-type: none"> Dual Fin PVC seals against the door Third Fin seals the gap between the product and the jamb Includes Cap to Hide Screws
SR-1405E		7', 8', 9', 10', 14', 16'	12	Rigid PVC/ Flexible PVC (Co-Extruded)	White, Sandstone Cream, Brown, Bronze, Black, Grey	<ul style="list-style-type: none"> Economical Works on gradual arches Nail or Screw in
SR-1404		7', 8', 9', 10', 12', 16', 18'	9	Rigid PVC/ Flexible PVC (Co-Extruded)	White, Sandstone Cream, Brown, Bronze, Black	<ul style="list-style-type: none"> Extra Wide Profile Flexible co-extruded cap to hide screws Dual Fin PVC seals against the door

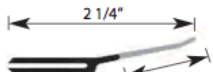
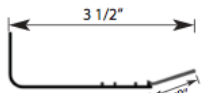
Side and Top Rigid PVC - Reverse Angle

Model	Image	Length	Box Quantity	Material	Colours	Description
SR-9001		24'	25	Rigid PVC/ Flexible PVC (Co-Extruded)	Grey Rigid PVC, Black Flexible PVC	<ul style="list-style-type: none"> Reverse Angle Clip-On PVC Clips onto reverse angle Clips Overtop of 1/4" Angle
SR-9002		24'	25	Rigid PVC/ Flexible PVC (Co-Extruded)	Black Rigid PVC, Black Flexible PVC	<ul style="list-style-type: none"> Reverse Angle Clip-On PVC Side Use – Clips onto Reverse Angle Also for Residential Use
SR-9003		9', 11', 13', 15', 17'	30	Rigid PVC/ Flexible PVC (Co-Extruded)	Black	<ul style="list-style-type: none"> Reverse Angle Bolt On Weatherstripping Bolts onto Reverse Angle Steel Jamb
SR-9004		200' Per Spool	200' Per Spool	Rigid PVC/ Flexible PVC (Co-Extruded)	White, Brown, Grey, Black	<ul style="list-style-type: none"> Reverse Angle Clip-On Vinyl Side Use – Clips onto Steel Jamb Also for Residential Use

Side and Top Steel

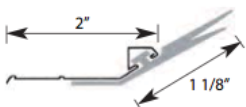

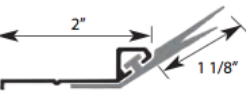
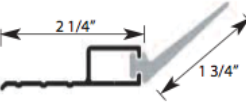
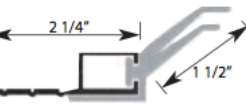
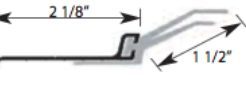
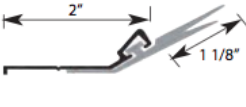

Model	Image	Length	Box Quantity	Material	Colours	Description
SS-7001		7', 8', 9', 10'	20	Galvanized Steel / Flexible PVC	Laminated Dark Oak, Laminated Medium Oak, White, Sandstone Cream, Charcoal Grey, Brown, Bronze, Black	<ul style="list-style-type: none"> Steel is Notched on Both Ends for Easier Installation Third Fin seals the gap between the product and the jamb Economical Dual Fin PVC seals against the door
		12', 14', 16', 18'	10			

Side and Top Aluminum

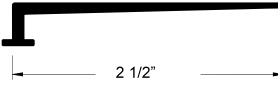
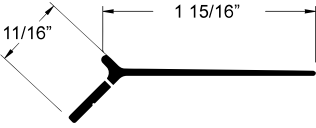

Model	Image	Length	Box Quantity	Material	Colours	Description
SA-5001		7', 8', 9', 10' 12', 14', 16', 18'	10	Aluminum / Flexible PVC	White, Sandstone Cream, Brown, Black, Dark Brown, Charcoal Grey, Laminated Dark Oak, Laminated Medium Oak, Iron Ore, Honey Cedar, Bronze, Mocha Brown	<ul style="list-style-type: none"> Painted Aluminum retainer Dual Fin PVC seals against the door Third Fin seals the gap between the product and the jamb Non-warping Color matched screws in each box Notched at 10' +under High heat applications
SA-1101		8', 10', 12', 14', 16', 24'	10	Aluminum / Flexible PVC	Mill Finish Aluminum, Black Flexible PVC	<ul style="list-style-type: none"> Aluminum Retainer Heavy Duty Single-Fin PVC
SA-1102		8', 10', 12', 14', 16', 18', 24'	8	Aluminum / Flexible PVC	Mill Finish Aluminum, Black Flexible PVC	<ul style="list-style-type: none"> Heavy Duty Dual Fin PVC Third Fin seals the gap between the product and the jamb Aluminum Retainer Specifically For Colder Climates
SA-1106		8', 10', 12', 14', 16', 18', 24'	15	Aluminum / Flexible PVC	Mill Finish Aluminum, Black Flexible PVC	<ul style="list-style-type: none"> Aluminum retainer Dual Fin PVC seals against the door Third Fin seals the gap between the product and the jamb
					Anodized Aluminum, Black Flexible PVC	
SA-1001		8', 9', 10', 12', 14', 16', 18', 24'	10	Aluminum / Flexible PVC	Mill Finish Aluminum, Black Flexible PVC	<ul style="list-style-type: none"> Aluminum retainer Dual Fin PVC seals against the door Third Fin seals the gap between the product and the jamb

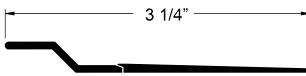
SEALS AND ACCESSORIES



Top Seal

Model	Image	Roll / Length	Material	Colors	Description
TS-300		150' per roll	Flexible Vinyl	Black	<ul style="list-style-type: none"> • Slides into standard 'U' shape retainer BR-1006 • Installed on top sections
TS-238		200' per roll	Flexible Vinyl	Black	<ul style="list-style-type: none"> • Slides into standard 'U' shape retainer BR-1006 • Installed on top sections
TS-534		100' per roll	Rigid Vinyl / Flexible Vinyl (Co-Extruded)	Black	<ul style="list-style-type: none"> • Installs on top sections • Offers additional draft Seal
TS-515		150' per box (3 x 50' coils)	Rigid Vinyl / Flexible Vinyl (Co-Extruded)	Black	<ul style="list-style-type: none"> • Installs on top sections • Offers additional draft Seal
TS-320		150' per box (3 x 50' coils)	Rigid Vinyl / Flexible Vinyl (Co-Extruded)	Black	<ul style="list-style-type: none"> • Installs on top sections • Offers additional draft Seal
TS-319		150' per box (3 x 50' coils)	Rigid Vinyl / Flexible Vinyl (Co-Extruded)	Black	<ul style="list-style-type: none"> • Installs on top sections • Offers additional draft Seal

Bottom “U” Rubber (PVC)



Model	Image	Roll / Length	Description
V1003 - 3"		200' Roll	<ul style="list-style-type: none"> • Flexible PVC, 3" Width • Compatible with ELTON's plastic and aluminum bottom retainers • Available in Black or Yellow
V1003 - 4"		200' Roll	<ul style="list-style-type: none"> • Flexible PVC, 4" Width • Compatible with ELTON's plastic and aluminum bottom retainers • Available in Black or Yellow
V1003 - 5"		150' Roll	<ul style="list-style-type: none"> • Flexible PVC, 5" Width • Compatible with ELTON's plastic and aluminum bottom retainers • Available in Black or Yellow
V1003 - 6.5"		100' Roll	<ul style="list-style-type: none"> • Flexible PVC, 6.5" Width • Compatible with ELTON's plastic and aluminum bottom retainers • Available in Black or Yellow
V1003-3-DF		200' Roll	<ul style="list-style-type: none"> • Flexible PVC, 3" Width • Compatible with ELTON's plastic and aluminum bottom retainers • U-Shape seal with added Drip Edge • Available in Black
V1003-4-DF		200' Roll	<ul style="list-style-type: none"> • Flexible PVC, 4" Width • Compatible with ELTON's plastic and aluminum bottom retainers • U-Shape seal with added Drip Edge • Available in Black
V1003-3-R-BLOCK		75' Per Roll	<ul style="list-style-type: none"> • Compatible with ELTON's plastic and aluminum bottom retainers • Highly effective at keeping pests out of places they don't belong • Available in Black, 3" Width
V1003-4-R-BLOCK		75' Per Roll	<ul style="list-style-type: none"> • Compatible with ELTON's plastic and aluminum bottom retainers • Highly effective at keeping pests out of places they don't belong • Available in Black, 4" Width

Thermoplastic Rubber (TPR) *Superior Weather Performance*



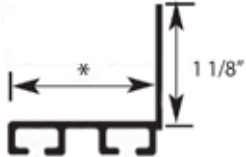
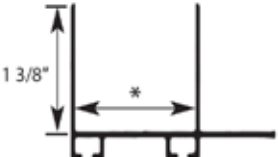
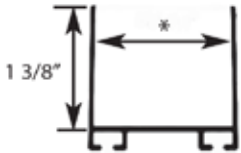
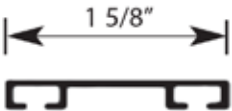
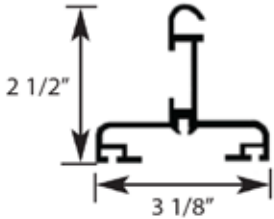

Model	Image	Roll / Length	Description
V1003-444		Coil	<ul style="list-style-type: none"> • TPR • 4" Width • Compatible with ELTON's plastic and aluminum bottom retainers • Used as an improved bottom seal or as a safety edge • Available in Black • Plugs also available
V1003-TPR-3		200' Roll	<ul style="list-style-type: none"> • TPR, 3" Width • Compatible with ELTON's plastic and aluminum bottom retainers • Available in Black
V1003-TPR-4		200' Roll	<ul style="list-style-type: none"> • TPR, 4" Width • Compatible with ELTON's plastic and aluminum bottom retainers • Available in Black

BOTTOM RETAINERS

Bottom Retainers - Aluminum

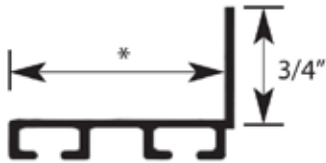
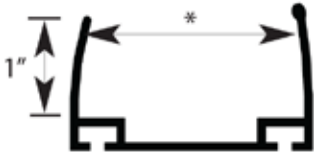
Model	Image	Length	Description
BA-1003		8', 10', 12', 14', 16', 24'	* For door thickness: 1-3/8", 1-5/8", 2"
BA-1004		24'	* For door thickness: 1-3/4", 2"
BA-1005		8', 10', 12', 14', 16', 24'	* For door thickness: 1-3/8", 1-1/2", 1-3/4", 2"
BA-1007		8', 10', 12', 14', 16', 24'	* For door thickness: 1-5/8"
BA-3011		25'	* For rolling steel door
BA-3011-1		25'	Flat Slat Adapter

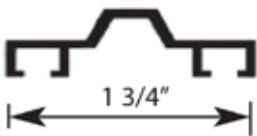
Bottom Retainers - Rigid PVC

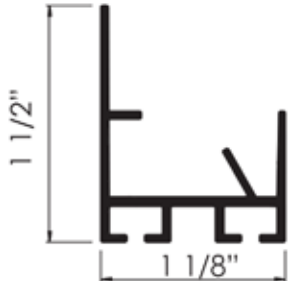
Model	Image	Length	Description
BR-1013		8', 10', 12' 14', 16', 24'	(Black) * For door thickness: 1-1/4", 1-3/8", 2" * Packaged 40 / Bag
BR-1006		8', 10', 12' 14', 16', 24'	(Black) With flexible fin to touch door face * For door thickness: 1-3/8", 1-1/2", 1-3/4", 2" * Packaged 16 / Bag
BR-1014		8', 10', 12' 14', 16', 24'	(Black) * For door thickness: 1-5/8" * Packaged 40 / Bag
BR-1015		8', 9', 10', 12', 14', 16', 24'	(Black) * For door thickness: 1-3/4" 8' and 9' - Packaged 50 / Bag 10', 12', 14', 16', 24' Packaged 25 / Bag
BR-1019		8', 10', 12' 14', 16', 24'	(Black) * For door thickness: 1-3/8", 2" * Packaged 32 / Bag
BR-599		10', 16'	(Black) * For door thickness: 1-1/8" * 10' - Packaged 20 pcs / Bag * 16' - Packaged 25 pcs / Bag

BRUSH SEALS

Brush Seals

Standard Brush	
Model	Bristle Width
RL-100	1" Bristle
RL-138	1 3/8" Bristle
RL-112	1 1/2" Bristle
RL-200	2" Bristle
RL-300	3" Bristle
RL-400	4" Bristle
RL-600	6" Bristle
<i>Standard Brush Comes in 6' Lengths</i>	



Heavy Brush	
Model	Bristle Width
RH-300	3" Bristle
RH-600	6" Bristle
<i>Heavy Brush Comes in 8' Lengths</i>	

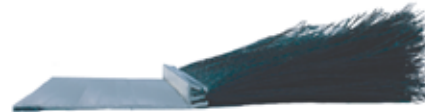

Viny Insert RV		
Model	Vinyl Width	Spool Lengths
RV-100	1" Vinyl Width	600'
RV-112	1 1/2" Vinyl Width	400'
RV-200	2" Vinyl Width	300'
RV-300	3" Vinyl Width	200'

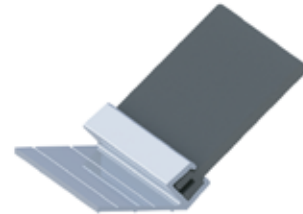

Dock Brush Kits	
1" Brush Kits	1 1/2" Brush Kits
• KIT5100S - For 6' Dock Plate	• KIT5112S - For 6' Dock Plate
• KIT7100S - For 8' Dock Plate	• KIT7112S - For 8' Dock Plate
Dock Brush Kits - Weldable Options	
1" Brush Kits	1 1/2" Brush Kits
• KIT5100W - For 6' Dock Plate	• KIT5112W - For 6' Dock Plate
• KIT7100W - For 8' Dock Plate	• KIT7112W - For 8' Dock Plate

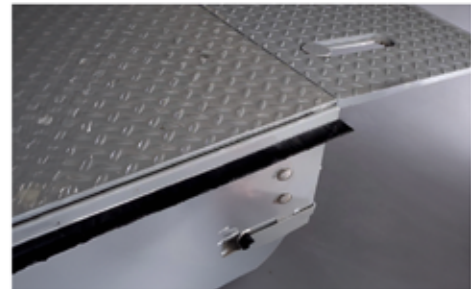

Dock Brush Kits Include:





- 2 Pieces of RA4007, 1-1/4" 90° Retainer
- 2 Pieces of 1" **OR** 1-1/2" Standard Brush Seal
- Self Tapping Fasteners
- Pre Cut to 5' Lengths for 6' docks 7' lengths for 8' docks

Optional Weldable Bracket

Brush Kit Available in 1" and 1-1/2"

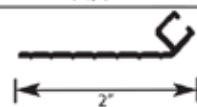
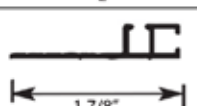
For Additional Bristle Length Please Contact for More Information

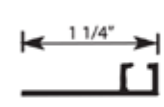
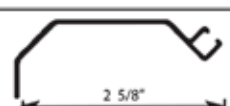
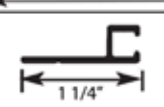
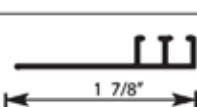
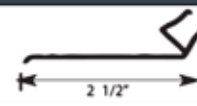
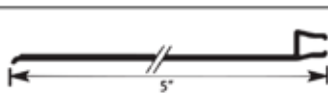
Retainers for Brush Seal

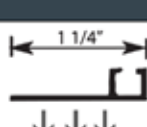
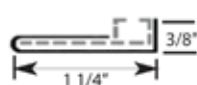

Model	Image	Available Lengths	Material
Standard Brush Retainers			
RA-4001		6', 8', 10', 12', 14', 16'	Aluminum Retainer • For Angle Application (45°) • For use with Standard brush or vinyl insert
RA-4002		6', 8', 10', 12', 14', 16'	Aluminum Retainer • For Angle Application (45°) • For use with Standard brush or vinyl insert
RA-4003		6', 8', 12', 16'	Aluminum Retainer • For Angle Application (90° & 80°) • For use with Standard brush or vinyl insert
RA-4006		6', 12'	Aluminum Retainer • For Angle Application (45°) • For use with Standard brush or vinyl insert
RA-4007		6', 8', 10', 12', 14', 16',	Aluminum Retainer • For Angle Application (90°) • For use with Standard brush or vinyl insert
RA-4009		12'	Aluminum Retainer • For Reverse Angle Rolling Steel Doors • For use with Standard brush or vinyl insert
RA-4010		6', 8', 10', 12', 14', 16'	Aluminum Retainer • For Angle Application (180°) • For use with Standard brush or vinyl insert
RA-4011		12'	Aluminum Retainer • For Angle Application (90° Double Track) • For use with Standard brush or vinyl insert
Heavy Brush Retainers			
RA-4004		8', 16'	Aluminum Retainer • For Angle Application (45°) • For use with Heavy brush
RA-4005		8', 16'	Aluminum Retainer • For Angle Application (180°) • For use with Heavy brush
RA-4012		8', 16'	Aluminum Retainer • For Angle Application (90°) • For use with Heavy brush
Dock Leveler Retainers			
RA-4007		6', 8', 10', 12', 14', 16',	Aluminum Retainer • For Angle Application (90°) • For use with Standard brush or vinyl insert
DL-4000		6', 8',	Galvanized Steel Retainer • Weldable to sides of Dock Leveler • RA-4007 aluminum retainer & Standard brush insert slides into this outer retainer

SEALS AND ACCESSORIES

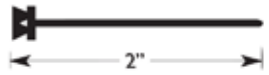
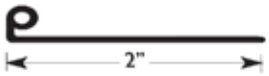

Threshold - Replacement Sweeps

Model	Image	Roll / Length	Description
V1016-0		<ul style="list-style-type: none"> • 100' Per Roll • Threshold (Including Adhesive) • Vinyl Colour: Black 	<ul style="list-style-type: none"> • Threshold • Installed on the ground below garage door as a second seal to prevent water from flowing into the garage • Can be driven over with vehicle
V1010		<ul style="list-style-type: none"> • 300' Per Roll • Vinyl Colour: Grey 	<ul style="list-style-type: none"> • Replacement sweep for One-Piece Door • Fits into the bottom of One-Piece Stanley™ doors
V1011		<ul style="list-style-type: none"> • 200' Per Roll • Vinyl Colour: Grey 	<ul style="list-style-type: none"> • Replacement sweep for One-Piece Door • Fits into the bottom of One-Piece Taylor™ doors

Hoses

Model	Image	Description	Roll / Length
3001-0		<ul style="list-style-type: none"> • TPR • Signal Tube • ID = 3/8" 	250' Per Roll
3002-0		<ul style="list-style-type: none"> • TPR • Gum Hose • ID = 1/2" • Installed in Bottom "U" Rubber for use as Safety Edge 	200' Per Roll

Handles - Exhaust Port

Image	Model	Material	Colour	Cut-out Size	Description
	AR-3007-0	Polyethylene	Black	6-3/8" x 3-5/8"	<ul style="list-style-type: none"> • Telescopic Door Handle • For Door Thickness 1-3/8" – 2"
	AR-3007-1	Polyethylene	Black	6-3/8" x 3-5/8"	<ul style="list-style-type: none"> • Telescopic Door Handle • For Door Thickness 1-3/8" – 2"
	3009-1-B	Polyethylene	Black	4.5" Diameter	<ul style="list-style-type: none"> • Exhaust Port • For Any Door Thickness

Spring Filler - Operator Clip

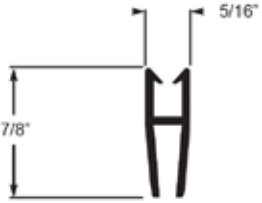
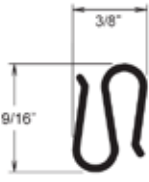
Model	Image	Description	Roll / Length
SPRBLK414		Spring Filler <ul style="list-style-type: none"> • For use with 5-1/4" or 6" springs • 1-3/8" ID 	12' per piece
AA-0429		Operator Rail Clip / Wire Manager <ul style="list-style-type: none"> • 100 per box • Liftmaster™ T-Rail • Black 	5' per piece
AA-516		Operator Rail Clip / Wire Manager <ul style="list-style-type: none"> • 150 per box • Black 	5' per piece

Nail On - for Wood Door

Model	Image	Roll / Length	Description
V1008		<ul style="list-style-type: none"> • 250' Per Roll • Vinyl Colour: Black 	<ul style="list-style-type: none"> • Bottom Nail-on for Wood Door • For 1-3/8" Doors • Light Duty
V1009		<ul style="list-style-type: none"> • 200' Per Roll • Vinyl Colour: Black 	<ul style="list-style-type: none"> • Bottom Nail-on for Wood Door • For 1-3/4" Doors • Heavy Duty
V1009-1		<ul style="list-style-type: none"> • 150' Per Roll • Vinyl Colour: Black 	<ul style="list-style-type: none"> • Bottom Nail-on for Wood Door • For 1-3/8" Doors • For Heavier Applications than V1009 • Provides Better Cushion

COMMERCIAL GARAGE DOOR WINDOWS

Commercial Windows

Glass Options

Most glass options can be ordered as single pane or insulated units

Stock Glass	Special Glass
<ul style="list-style-type: none"> • Double strength (Annealed/Float) glass - 3mm (1/8") • Tempered • Tinted • Acrylic (Plexiglas) • Polycarbonate (Lexan) 	<ul style="list-style-type: none"> • Polished Georgian Wire • Low-E • Breather Tubes • Argon Filled • Reflective

Frames For Insulated Doors

Elton's injection molded frames deliver the best in quality and appearance for your commercial door. The unique, screw-together design makes installation simple – and our polypropylene frames will not discolour! Please see the chart below for specifications, colours, glass options and door thicknesses.



0120

Screw-Together Window

Model	Frame Size (tip-to-tip)	Cut-out Size	Vision Area
0120	12 15/16" Outside Diameter	11 15/16" Diameter	10 3/16" Inside Diameter
	328mm Outside Diameter	303mm Diameter	274mm Inside Diameter

Frame Colour	Glass Options	Box Quantity						
		PAN	1 3/8"	1 1/2"	1 5/8"	1 3/4"	2"	FO
Black, White	Sealed Plexi, Sealed Lexan	N/A	N/A	16	16	12	12	16



0624

Screw-Together Window

Model	Frame Size (tip-to-tip)	Cut-out Size	Vision Area
0624	23 13/16" x 5 11/16"	22 15/16" x 4 7/8"	21 1/4" x 3 1/4"
	605mm x 144mm	583mm x 124mm	541mm x 82mm

Frame Colour	Glass Options	Box Quantity						
		PAN	1 3/8"	1 1/2"	1 5/8"	1 3/4"	2"	FO
Black, White, Cream, Sandstone, Brown, Grey	See chart for glass options	24	18	16	16	16	14	18



0824

Screw-Together Window

Model	Frame Size (tip-to-tip)	Cut-out Size	Vision Area
0824	23 15/16" x 7 15/16"	23 1/8" x 7 1/8"	21 9/16" x 5 1/2"
	608mm x 202mm	583mm x 181mm	547mm x 140mm

Frame Colour	Glass Options	Box Quantity							
		PAN	1 3/8"	1 1/2"	1 5/8"	1 3/4"	2"	3"	FO
Black, White, Cream, Sandstone, Brown, Grey	See chart for glass options	N/A	14	14	12	12	10	14	14

1224

For flush doors
 Screw-Together Window



Model	Frame Size (tip-to-tip)	Cut-out Size	Vision Area						
1224	25 1/8" x 13 1/8"	24 1/16" x 12"	21 11/16" x 9 5/8"						
	638mm x 334mm	611mm x 305mm	551mm x 245mm						
Frame Colour	Glass Options	Available door Thickness / Box Quantity							
		PAN	1 3/8"	1 1/2"	1 5/8"	1 3/4"	2"	3"	FO
Black, White, Cream, Sandstone, Brown, Grey	See chart for glass options	N/A	8	8	6	6	6	8	8

1225

For Ribbed doors
 Screw-Together Window

Frames For Deep Ribbed Pan Door

1225 will fit most door manufacturers' ribbed panels. The tabs on our 1225 frame fit right into the deep ribs of the door. This saves installation time, as there's no need to fill the ribs with caulking. The interior frame for a pan door is designed to go right over the deep ribs perfectly, lining up the screw holes with the exterior frame. You can mix and match 1224 & 1225 to fit ribbed or flush sections for pan or insulated doors.

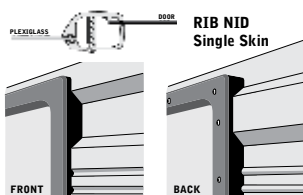

Model	Frame Size (tip-to-tip)	Cut-out Size	Vision Area						
1225	25 1/8" x 13 1/8"	23 7/8" x 11 13/16"	21 11/16" x 9 5/8"						
	638mm x 334mm	606mm x 300mm	552mm x 246mm						
Frame Colour	Glass Options	Box Quantity							
		PAN	1 3/8"	1 1/2"	1 5/8"	1 3/4"	2"	3"	FO
Black, White, Cream, Sandstone, Brown, Grey	See chart for glass options	15	8	8	6	6	6	6	10

1326

Screw-Together Window



Model	Frame Size (tip-to-tip)	Cut-out Size	Vision Area						
1326	26 1/8" x 13 9/16"	25 1/16" x 12 9/16"	23 7/16" x 10 13/16" Corner Cut 4" Radius						
	663mm x 344mm	637mm x 319mm	595mm x 275mm Corner Cut 101.60mm Radius						
Frame Colour	Glass Options	Box Quantity							
		PAN	1"	1 3/8"	1 1/2"	1 5/8"	1 3/4"	2"	FO
Black, White	Sealed Plexi, Sealed Lexan	N/A	8	8	8	8	6	6	8

*1326 Cut-out is oval. Please call us for template.

1634

Screw-Together Window



Model	Frame Size (tip-to-tip)	Cut-out Size	Vision Area						
1634	35 1/8" x 17 1/8"	33 7/8" x 15 7/8"	31 3/4" x 13 11/16"						
	892mm x 435mm	861mm x 403mm	806mm x 348mm						
Frame Colour	Glass Options	Box Quantity							
		PAN	1 3/8"	1 1/2"	1 5/8"	1 3/4"	2"	3"	FO
Black, White, Cream, Sandstone, Brown, Grey	See chart for glass options	N/A	4	4	4	4	4	6	6

COMMERCIAL GARAGE DOOR WINDOWS

Commercial Windows

1324

Screw-Together Window



Model	Frame Size (tip-to-tip)	Cut-out Size	Vision Area					
1324	26 3/4" x 14 1/2"	25 5/8" x 13 3/8"	23 7/8" x 11 9/16"					
	679mm x 369mm	651mm x 340mm	606mm x 294mm					
Frame Colour	Glass Options	Box Quantity						
		PAN	1 3/8"	1 1/2"	1 5/8"	1 3/4"	2"	FO
Black, White	See chart for glass options	N/A	8	8	6	6	6	8

1325

Clip-Together Window



Model	Frame Size (tip-to-tip)	Cut-out Size	Vision Area					
1325	26 3/4" x 14 1/2"	25 5/8" x 13 1/2"	23 7/8" x 11 9/16"					
	679mm x 369mm	651mm x 340mm	606mm x 294mm					
Frame Colour	Glass Options	Box Quantity						
		PAN	1 3/8"	1 1/2"	1 5/8"	1 3/4"	2"	FO
Black	Sealed Plexi, Sealed Lexan	N/A	N/A	8	8	N/A	N/A	N/A

1328

Clip-Together Window



Model	Frame Size (tip-to-tip)	Cut-out Size	Vision Area					
1328	28 9/16" x 12 13/16"	27 3/8" x 11 3/4"	25 5/8" x 9 7/8" Corner Cut 2 3/4" Radius					
	725mm x 325mm	695mm x 298mm	651mm x 251mm Corner Cut 69.85mm Radius					
Frame Colour	Glass Options	Box Quantity						
		PAN	1 3/8"	1 1/2"	1 5/8"	1 3/4"	2"	FO
Black	Sealed Plexi, Sealed Lexan	N/A	N/A	8	8	N/A	N/A	N/A

*1328 Cut-out is oval. Please call us for template.

Ventilation

Louver



- Powder coated white for Durability
- Screen Keeps Bugs out
- Fits virtually any window size

* Standard size: Elton 1224
 * Number of louver rows depends on window size
 * Please call us for more information on custom sizes

Slider



- Controls air flow for all seasons
- Screened Sliding Window allows for ventilation and keeps insects out
- Fits into standard Elton 1224 Commercial Window frame
- Available for 2" door panels

* Standard size: Elton 1224
 * Single glass only

Expanded Aluminum



- Ideal for underground garages
- Mill finish aluminum
- Flattened diamond pattern
- Fits virtually any window size

* Standard size: Elton 1224
 * Please call us for more information on custom sizes



Configuration Ideas:

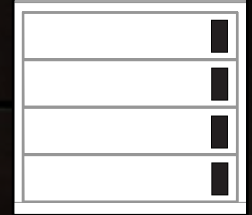

714

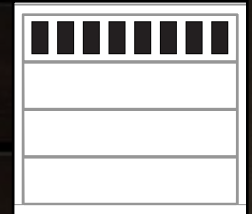

714

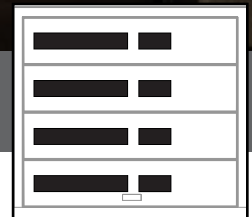

714 + 714

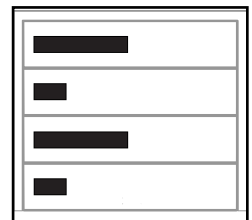

714 + 714

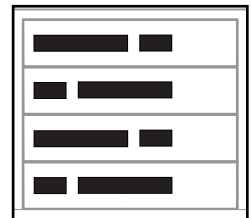

714 + 714

714 SLIMLINE WINDOW SERIES

High Performance Precision Construction

- Elton's proprietary advanced resin technology
- Maximum weatherability
- Paintable (no primer needed)
- One piece injection moulded construction

Endless Design Potential

- Clean lines enhance both modern & traditional architecture
- Fits vertically & horizontally on 18", 21" & 24" panels
- Same profile as 741 ideal for stacked combination configurations

SPECIFICATIONS:

PART NUMBER:	GD 0714
TIP TO TIP:	6-15/16" x 13-3/4"
CUT OUT:	5-15/16" x 12-13/16"
VISION AREA:	3-15/16 x 10-3/4"
PANEL THICKNESS:	1 3/8" and 2" for single glass
	1 3/8", 1 3/4" and 2" for insulated glass

Glass Options:
Insulated or Single Pane



CLEAR

FROSTED

TINTED

Frame Color Options:

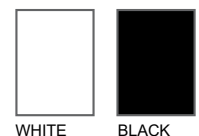

WHITE

BLACK

eltonmanufacturing.com | sales@eltonmanufacturing.com | 1-800-297-8299

RESIDENTIAL GARAGE DOOR



Configuration Ideas:



741

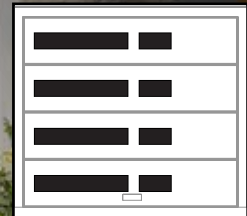

741 + 714

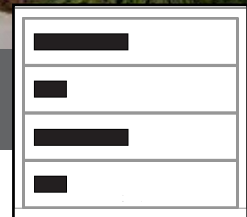

741 + 714

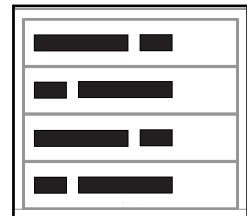

741 + 714

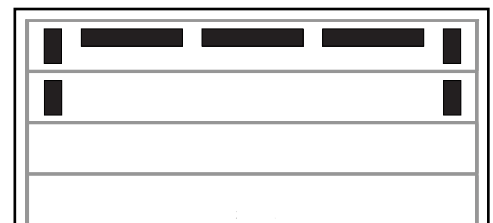

714 + 741

741 SLIMLINE WINDOW SERIES

High Performance Precision Construction

- Elton's proprietary advanced resin technology
- Maximum weatherability
- Paintable frame options available
- One piece injection moulded construction

Endless Design Potential

- Clean lines enhance both modern & traditional architecture
- Same profile as 714 ideal for stacked combinations

SPECIFICATIONS:

PART NUMBER:	GD 0741
TIP TO TIP:	6-15/16" x 40-13/16"
CUT OUT:	5-15/16" x 40-1/16"
VISION AREA:	3-15/16" x 37-7/8"
PANEL THICKNESS:	1 3/8" and 2" for single glass
	1 3/8", 1 3/4" and 2" for insulated glass

Glass Options:
Insulated or Single Pane



Frame Color Options:

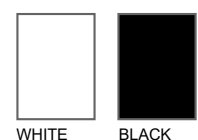

RESIDENTIAL GARAGE DOOR WINDOWS



Classic Elegance

ENDLESS
POSSIBILITIES

The "Stackable Series"

Newly Designed EP Frames

Elton's new **Stackable Series** introduces a fresh, modern design to any garage door. With a sleek, stylish smooth profile, it's a revolution in garage decor, blending form and function to cater to Endless Possibilities.

Highlights

- Injection Moulded
- Smooth Profile
- Colors: Black, White, Tan (Paintable)
- Stylish Look With Flexibility
- Available for 1 3/4" & 2" Door Thickness
- Offered in 4 Sizes

SIZES:

MODEL	OUTSIDE DIMENSIONS
EP 848	10" x 50"
EP 836	10" x 38"
EP 822	10" x 24"
EP 764	9" x 66"



Shown in 7 x 64 (9" x 66" O.D.)

Contemporary Windows

SLIMLINE SERIES:



741 + 714 HORIZONTAL



714 + 714 VERTICAL

Model	Available for Non Insulated Doors	Measurements	Outside Frame (Tip to Tip)	Cut - Out Size	Vision Area
741	coming soon	Imperial	40 13/16" x 6 15/16"	40 1/16" x 5 15/16"	37 7/8" x 3 15/16"
		Metric	1037mm x 176mm	1018mm x 151mm	962mm x 100mm
714	coming soon	Imperial	13 3/4" x 6 15/16"	12 13/16 x 5 15/16"	10 3/4" x 3 15/16"
		Metric	349mm x 176mm	325mm x 151mm	273mm x 100mm

EP STACKABLE SERIES:



EP 848



EP 836

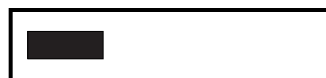

EP 822



EP 764

Model	Measurements	Outside Frame (Tip to Tip)	Cut - Out Size	Vision Area
EP 848	Imperial	10" x 50"	9" x 49"	6-3/4" x 46-3/4"
	Metric	254 mm x 1270 mm	228.6 mm x 1244.6 mm	171.45 mm x 1187.45 mm
EP 836	Imperial	10" x 38"	9" x 37"	6-3/4" x 34-3/4"
	Metric	254 mm x 965.2 mm	228.6 mm x 939.8 mm	171.45 mm x 882.65 mm
EP 822	Imperial	10" x 24"	9" x 23"	6-3/4" x 20-3/4"
	Metric	254 mm x 609.6 mm	228.6 mm x 584.2 mm	171.45 mm x 527.05 mm
EP 764	Imperial	9" x 66"	8" x 65"	5-3/4" x 62-3/4"
	Metric	228.6 mm x 1676.4 mm	203.2 mm x 1651 mm	146.05 mm x 1593.85 mm

Available for 1-3/4" and 2" door thickness. Insulated glass only.

RESIDENTIAL GARAGE DOOR WINDOWS

Classic Windows

SHORT PANEL:



Model	Snap - In Insert	Available for Non Insulated Doors	Measurements	Outside Frame (Tip to Tip)	Cut - Out Size	Vision Area
1319	x	x	Imperial	19 1/8" x 12 3/4"	18 5/16" x 11 13/16"	16 11/16" x 10 3/16"
			Metric	488mm x 323mm	464mm x 300mm	423mm x 259mm
1419	✓	✓	Imperial	19 3/4" x 14 7/16"	19 1/8" x 13 13/16"	16 3/4" x 11 5/8"
			Metric	502 x 367mm	485mm x 350mm	426mm x 296mm
1420	✓	✓	Imperial	19 9/16" x 14 1/4"	18 13/16" x 13 5/8"	16 3/4" x 11 1/2"
			Metric	497mm x 362mm	478mm x 346mm	425mm x 292mm
1520	✓	✓	Imperial	20 5/8" x 15 7/16"	19 1/2" x 14 3/8"	16 3/4" x 11 9/16"
			Metric	524mm x 392mm	495mm x 365mm	426mm x 294mm
1622	x	x	Imperial	21 1/8" x 15 11/16"	20 1/4" x 14 3/16"	18 5/8" x 13 3/16"
			Metric	537mm x 378mm	473mm x 354mm	515mm x 376mm
1421*	x	✓	Imperial	21" x 13 9/16"	20 1/16" x 12 11/16"	18 1/4" x 10 13/16"
			Metric	533mm x 344mm	510mm x 322mm	464mm x 275mm
1521*	x	x	Imperial	20 3/4" x 14 7/8"	19 7/8" x 13 15/16"	17 7/8" x 12"
			Metric	527mm x 378mm	505mm x 354mm	454mm x 304mm

**1421 and 1521 are Non-Stock Items. Please call for custom run details.*

INTERMEDIATE PANEL:



Model	Snap - In Insert	Available for Non Insulated Doors	Measurements	Outside Frame (Tip to Tip)	Cut - Out Size	Vision Area
1427	✓	x	Imperial	26 1/2" x 14 5/8"	25 5/8" x 13 7/16"	23 3/4" x 11 9/16"
			Metric	673mm x 371.5mm	651mm x 341mm	603mm x 294mm

LONG PANEL:



Model	Snap - In Insert	Available for Non Insulated Doors	Measurements	Outside Frame (Tip to Tip)	Cut - Out Size	Vision Area
1542	✓	✓	Imperial	42 15/16" x 15 3/4"	42 1/16" x 14 3/4"	40 1/16" x 12 13/16"
			Metric	1090mm x 400mm	1068mm x 376mm	1018mm x 325mm
1440	✓	✓	Imperial	42 3/8" x 14 1/4"	41 3/4" x 13 11/16"	39 11/16" x 11 1/2"
			Metric	1075mm x 362mm	1060mm x 348mm	1008mm x 292mm

Residential Inserts

SHORT PANEL:



LONG PANEL:

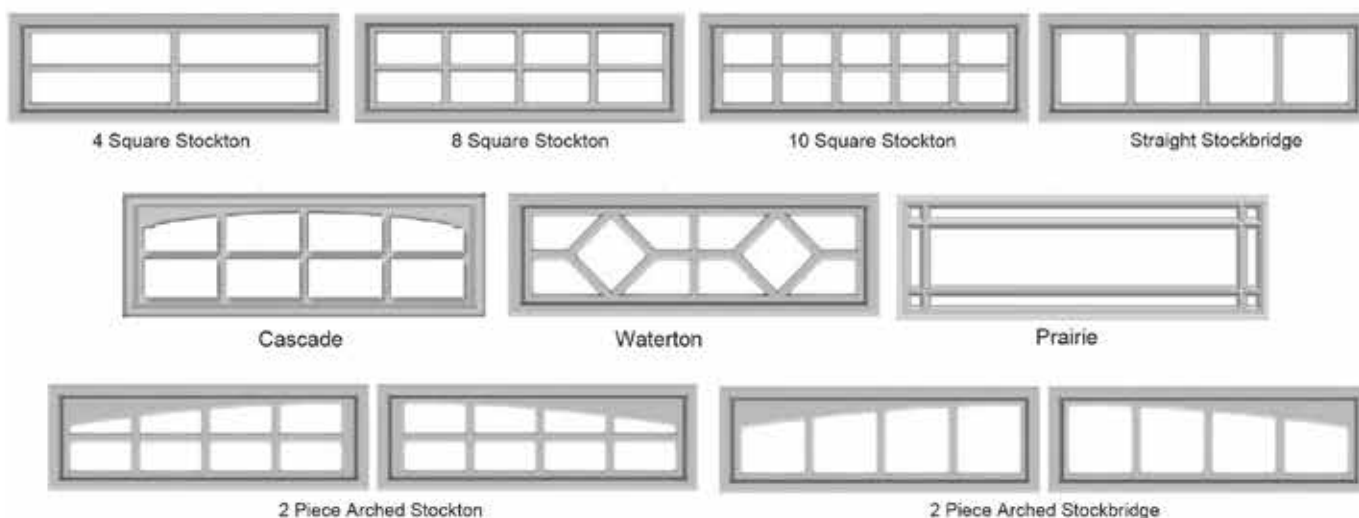

INTERMEDIATE PANEL:

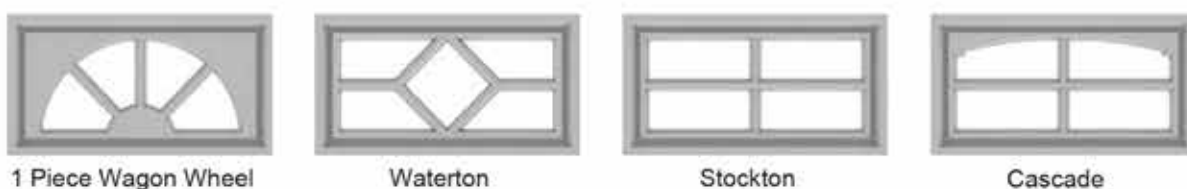

** Insert designs may differ between frame sizes. For current availability by size, please visit our website www.eltonmanufacturing.com.*

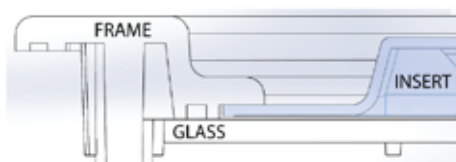

• Snap in-insert from front of frame with glass sealed to frame

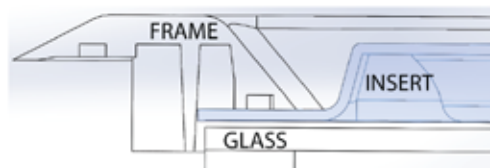

• Lay in-insert from front of frame with insert sealed to frame



Elton
MANUFACTURING

Elton Manufacturing
1265 Aerowood Drive, Mississauga
ON L4W 1B9
1-800-297-8299
sales@eltonmanufacturing.com
eltonmanufacturing.com

QUALITY | INNOVATION | TRUST